

Compact mobile crane Grue mobile compacte

LTC 1045-3.1

Technical Data Caractéristiques techniques

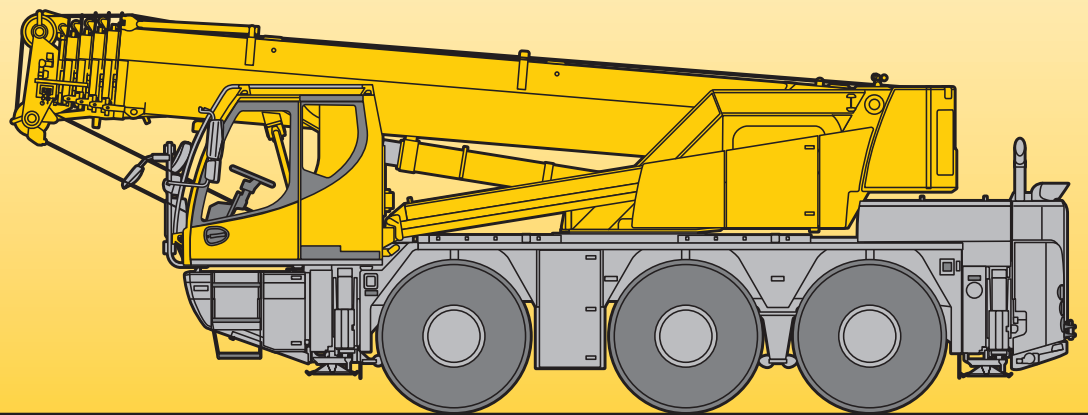

LIEBHERR

Dimensions - Operating on road Encombrement - Déplacement sur route

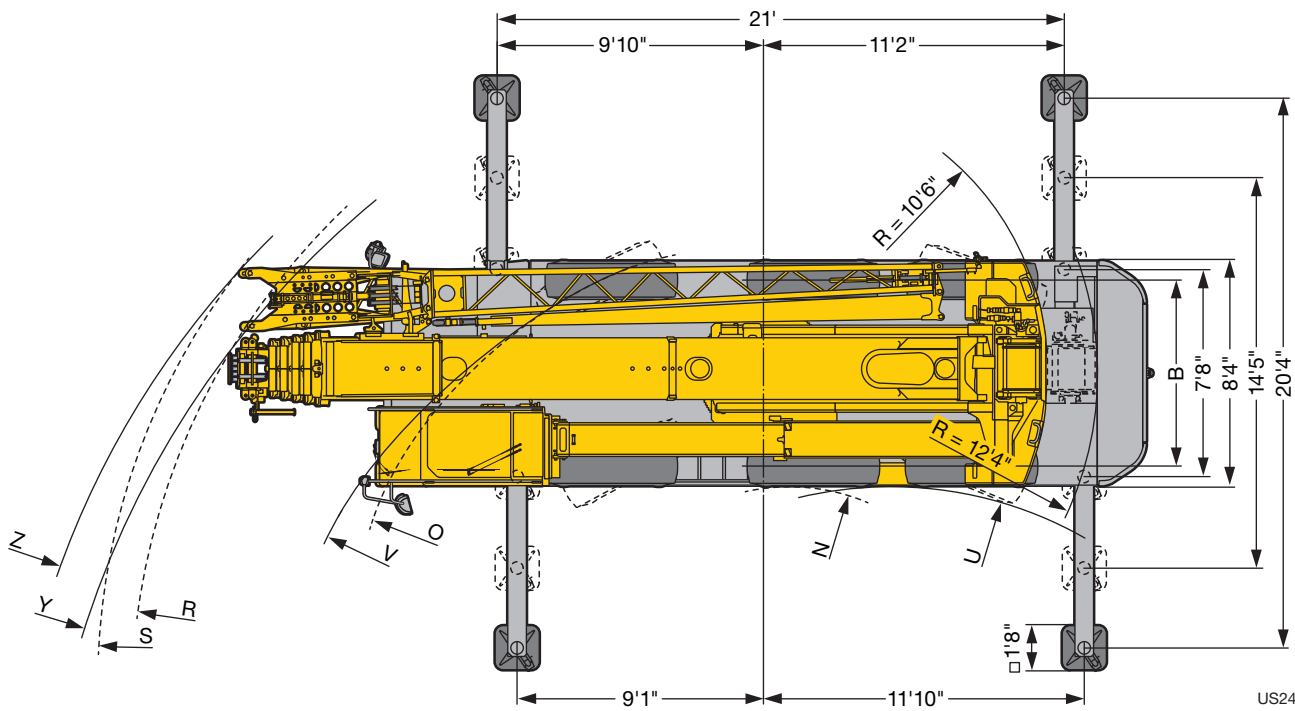
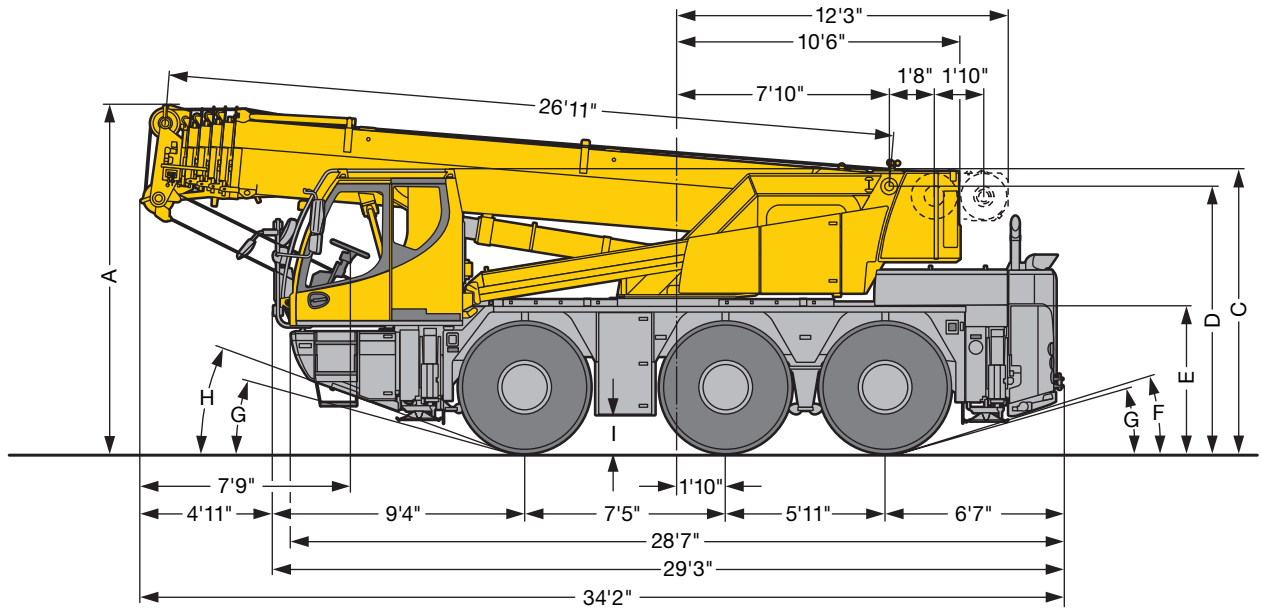

US2423.01

	Dimensions · Encombrement									
	A	A 0'4"*	B	C	D	E	F	G	H	I
385/95 R 25 (14.00 R 25)	12'7"	12'3"	6'11"	10'2"	9'7"	5'2"	13°	11°	16°	1'1"
445/95 R 25 (16.00 R 25)	12'9"	12'5"	6'11"	10'4"	9'9"	5'4"	15°	13°	18°	1'3"

* lowered · abaissé

	Dimensions · Encombrement							
	U	V	Y	Z	N	O	R	S
385/95 R 25 (14.00 R 25)	14'3"	24'5"	31'2"	32'11"	8'1"	17'3"	24'8"	26'3"
445/95 R 25 (16.00 R 25)	17'2"	26'11"	33'3"	34'11"	9'1"	17'11"	24'10"	26'5"

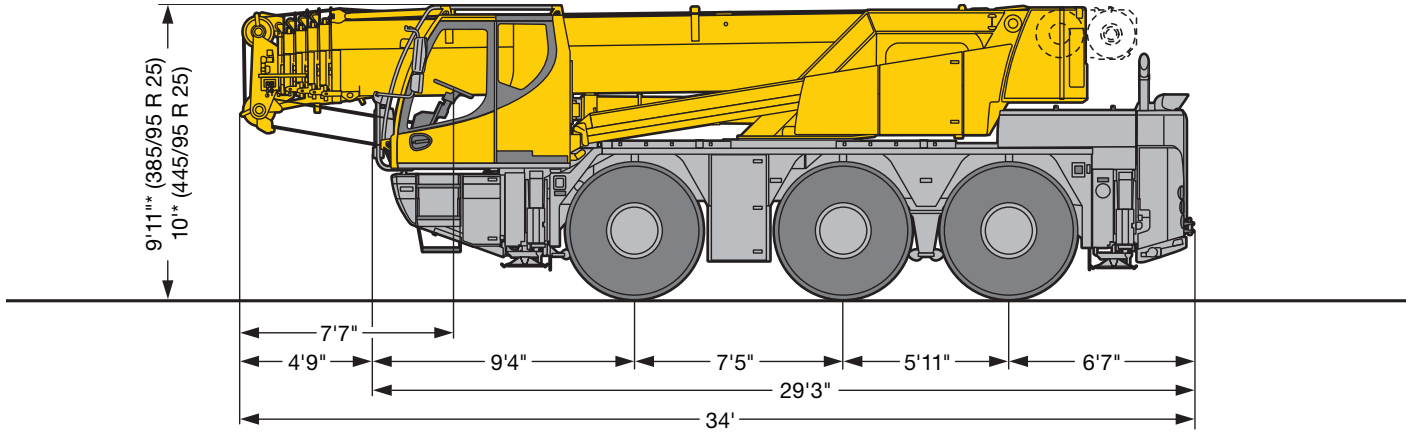

Dimensions - Lowest clearance Encombrement - Faible hauteur de passage

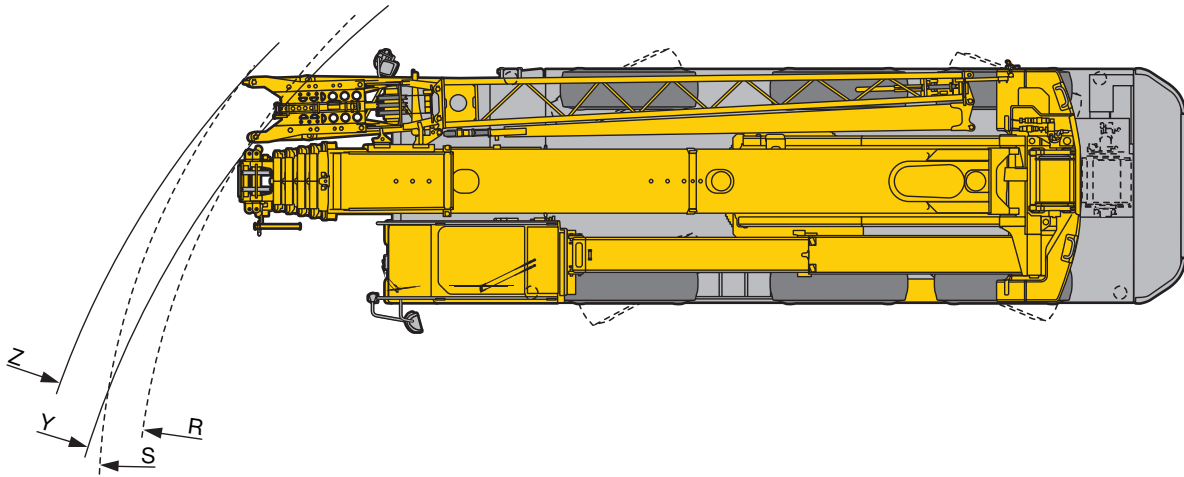

*4" lowered - abaissé





US2424

Dimensions - Encombrement				
				
	Y	Z	R	S
385/95 R 25 (14.00 R 25)	31'	32'10"	24'7"	26'1"
445/95 R 25 (16.00 R 25)	32'10"	34'9"	24'9"	26'5"

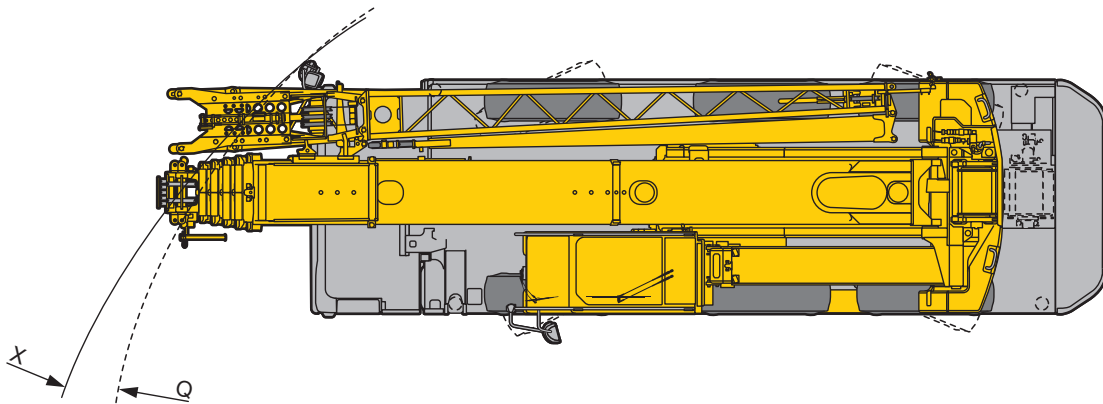
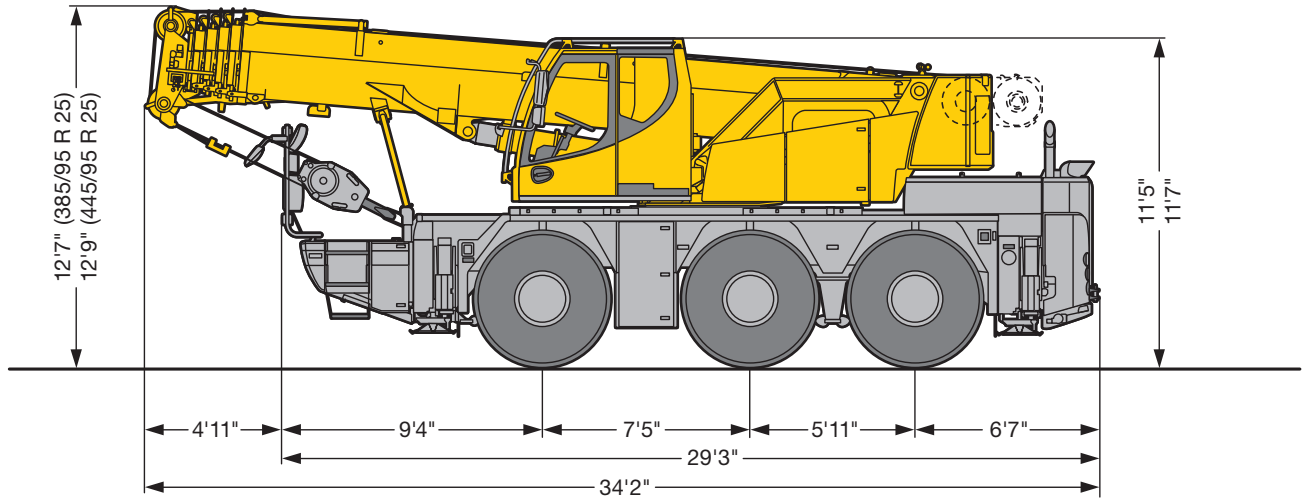
Dimensions - Procedure on site
Encombrement - Déplacement sur le chantier



US2425

Dimensions · Encombrement		
		
	X	Q
385/95 R 25 (14.00 R 25)	30'4"	23'4"
445/95 R 25 (16.00 R 25)	32'7"	23'9"

Dimensions - Reduced turning radius
Encombrement - Rayon de braquage réduit

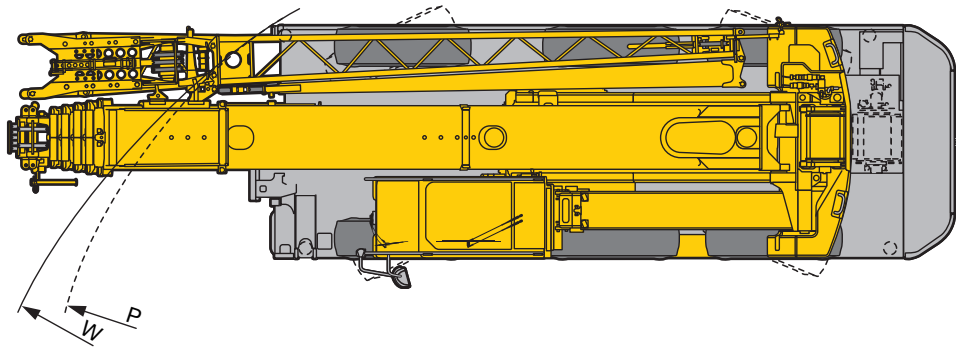
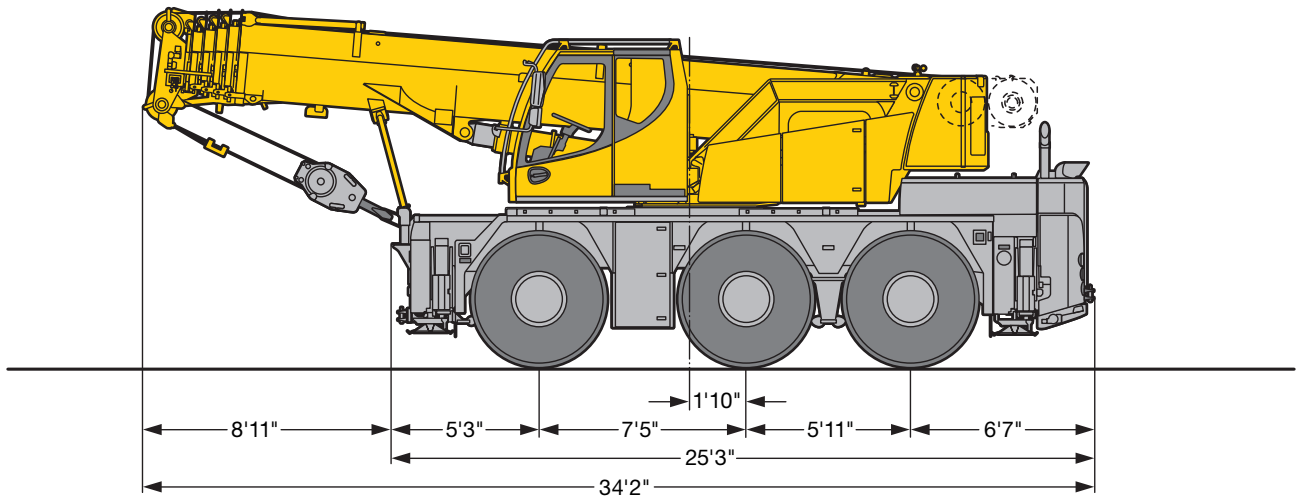

US2432

Dimensions · Encombrement		
	W	P
385/95 R 25 (14.00 R 25)	27'2"	20'
445/95 R 25 (16.00 R 25)	29'7"	20'7"

Dimensions - Lifting of the cab by the telescopic arm
Encombrement - Levage de la cabine au-dessus du bras télescopique

optional · en option

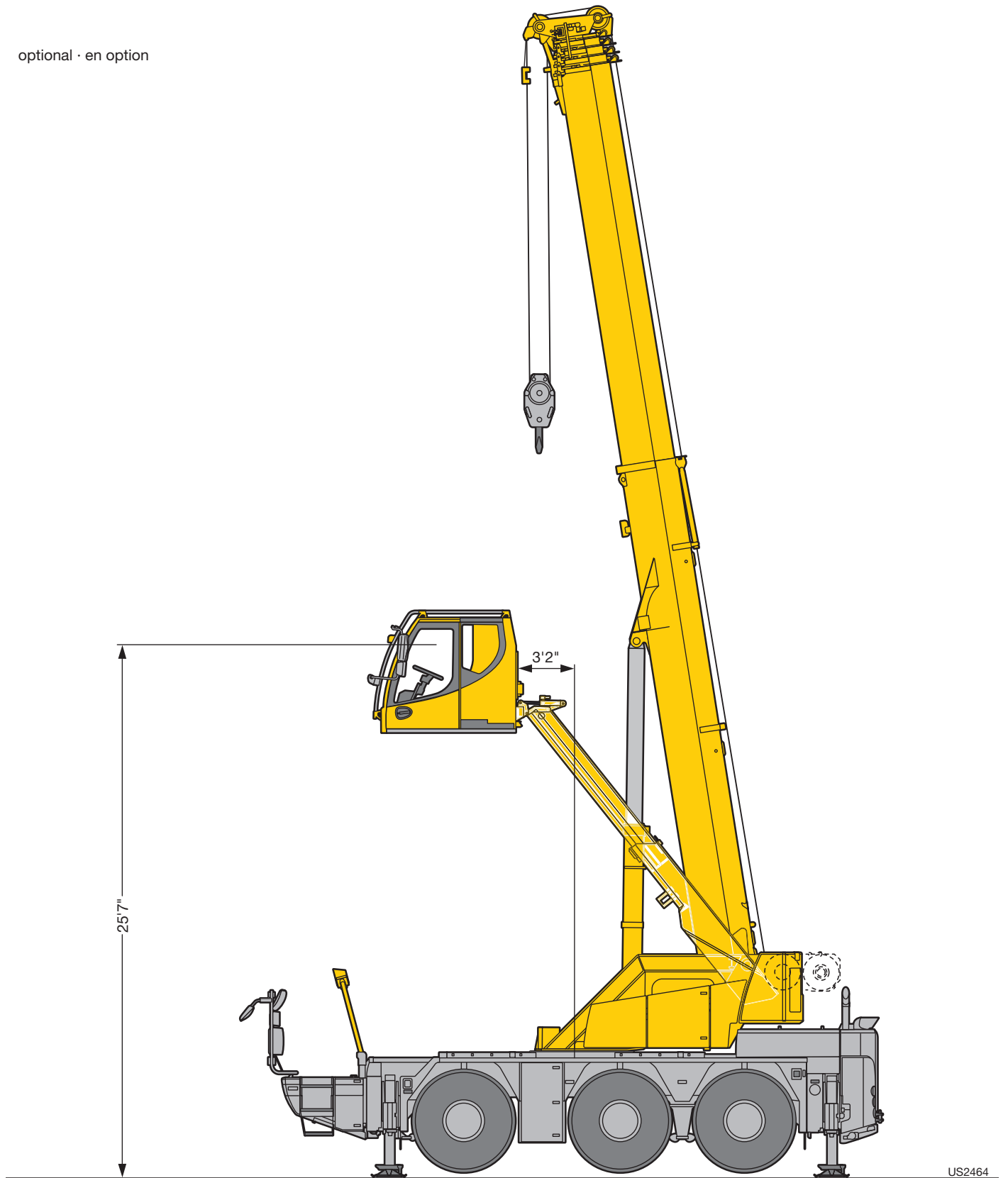

US2464

Weights Poids



Axle Essieu	1	2	3	Total weight lbs Poids total lbs
lbs	26400	26400	26400	79200 ¹⁾

¹⁾ with 14330 lbs counterweight and folding jib · avec contrepoids 14330 lbs et fléchette pliante



Load · Forces de levage kips	No. of sheaves · Poulies	No. of lines · Brins	Weight · Poids lbs
99.2	5	10	880
71.2	3	7	620
31.3	1	3	430
10.6	–	1	165

Working speeds Vitesses







		1	2	3	4	5	6	R 1	R 2	
385/95 R 25 (14.00 R 25)		0 – 5.2	8	12.9	19.8	30.8	50	0 – 5.5	13.6	39 %
445/95 R 25 (16.00 R 25)		0 – 5.7	8.8	14	21.6	33.6	50	0 – 6	14.8	36 %



Drive Mécanismes	infinitely variable en continu	Rope diameter / length Diamètre / Longueur du câble	Max. single line pull Effort au brin maxi.
	0 – 364 ft/min single line ft/min au brin simple · per tiro diretto	0.59" / 607'	10790 lbs
	0 – 364 ft/min single line ft/min au brin simple	0.59" / 607'	10790 lbs
	0 – 1,9 rpm		
	approx. 65 seconds to reach 83° boom angle env. 65 s jusqu'à 83°		
	approx. 280 seconds for boom extension from 27 ft – 118 ft env. 280 s pour passer de 27 ft – 118 ft		

Lifting capacities Forces de levage

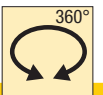
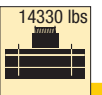
T













ft	27 ft	36 ft	45 ft	54 ft	63 ft	72 ft	82 ft	91 ft	100 ft	109 ft	118 ft	ft
10	97.8	94.2	85	70.8	68.5	58	45.9					10
11	92.2	91.5	81.7	71.2	68	57.7	45.2					11
12	87.1	86.5	78.4	71.7	67.4	57.4	44.2	36				12
13	81.9	81.3	75.5	72.1	66.8	56.8	43.2	35.7				13
14	76.9	77.1	74.9	71	66.2	55.9	42.2	35.3	28			14
15	72.3	72.9	71.6	69.4	65.1	55.1	41.1	35	28.6			15
16	68.2	68.7	67.3	65.4	62.8	54.3	40	34.6	28.3	21		16
17	63.7	64.5	64	61.9	60.3	53.4	38.7	34.2	28	23.1		17
18	57.9	60.5	60.2	59.5	57.9	52.6	37.5	33.7	27.6	22.9		18
19	46.4	57	56.8	56.4	54.6	51.5	36.3	33	27.3	22.6	18.1	19
20		53.5	53.6	53.8	50.6	49.2	35	32.1	27	22.4	18	20
22		48.2	48.6	47	45.3	43.1	32.7	30.5	26.2	21.8	17.8	22
24		42.7	43.2	41.5	40.6	38.3	31.3	28.8	25.3	21.2	17.6	24
26		38.5	38.9	37	36.3	34.4	30.2	27.2	24.3	20.6	17.4	26
28		32.7	35.2	34.5	32.8	31.1	29	25.9	23.4	20	17.1	28
30			32.3	31.4	29.9	28.4	27.9	24.5	22.5	19.3	16.7	30
32			29.5	28.8	27.4	26	25.9	23.2	21.5	18.7	16.3	32
34			26.8	26.5	25.2	24.7	23.9	21.9	20.5	18.1	15.9	34
36			24.4	24.5	23.3	23.3	22.1	20.7	19.5	17.5	15.4	36
38				22.6	21.7	21.7	20.6	19.4	18.6	16.9	15.1	38
40				20.8	20.1	20.2	19.2	18.1	17.8	16.4	14.7	40
45				17.2	17.5	17.2	16.3	16.2	15.3	14.5	13.7	45
50					15	14.6	14.1	14	13.1	12.6	12.6	50
55					13	12.6	12.7	12.2	11.4	11.3	10.9	55
60						11	11.1	10.6	10.3	10.1	9.6	60
65							9.5	9	9.1	8.9	8.4	65
70							8.4	8.2	8	7.8	7.4	70
75								7.4	7.1	6.9	6.5	75
80								6.7	6.4	6.2	5.8	80
85									5.7	5.5	5.1	85
90									5.1	4.9	4.5	90
95										4.4	4	95
100										3.9	3.5	100
105											3.1	105
110											2.7	110

t_142_50021_00_001

Lifting capacities Forces de levage

T





	 27 – 118 ft	 21 x 20.3 ft	 ±10° n.v.*	 14330 lbs	85%								
	 ft	27 ft	36 ft	45 ft	54 ft	63 ft	72 ft	82 ft	91 ft	100 ft	109 ft	118 ft	 ft
10		99.4	94.2	85	70.8	68.5	58	45.9					10
11		98.4	93.9	81.7	71.2	68	57.7	45.2					11
12		92.8	89.6	78.4	71.7	67.4	57.4	44.2	36				12
13		87	83.6	75.5	72.1	66.8	56.8	43.2	35.7				13
14		80.8	78.8	74.9	71	66.2	55.9	42.2	35.3	28			14
15		74.7	74.3	71.6	69.4	65.1	55.1	41.1	35	28.6			15
16		69.4	70.3	67.4	65.4	62.8	54.3	40	34.6	28.3	21		16
17		64.4	67.2	64.4	62	60.3	53.4	38.7	34.2	28	23.1		17
18		57.9	63.6	62	59.6	57.9	52.6	37.5	33.7	27.6	22.9		18
19		46.4	60.1	59.3	56.4	54.6	51.5	36.3	33	27.3	22.6	18.1	19
20			56.7	56.1	53.9	50.6	49.2	35	32.1	27	22.4	18	20
22			50.9	49	47	45.3	43.1	32.7	30.5	26.2	21.8	17.8	22
24			46.1	43.8	41.5	40.6	38.3	31.3	28.8	25.3	21.2	17.6	24
26			40.4	39.1	37	36.3	34.4	30.2	27.2	24.3	20.6	17.4	26
28			32.7	35.2	34.5	32.8	31.1	29	25.9	23.4	20	17.1	28
30				32.7	31.4	29.9	28.4	27.9	24.5	22.5	19.3	16.7	30
32				29.6	28.8	27.4	26	25.9	23.2	21.5	18.7	16.3	32
34				26.8	26.5	25.2	24.7	23.9	21.9	20.5	18.1	15.9	34
36				24.4	24.5	23.3	23.3	22.1	20.7	19.5	17.5	15.4	36
38					22.6	21.7	21.7	20.6	19.4	18.6	16.9	15.1	38
40					20.8	20.1	20.2	19.2	18.1	17.8	16.4	14.7	40
45					17.2	17.5	17.2	16.3	16.2	15.3	14.5	13.7	45
50						15	14.7	14.1	14	13.2	12.6	12.7	50
55						13.1	12.6	12.7	12.3	11.5	11.4	11.1	55
60							11.1	11.1	10.7	10.4	10.2	9.7	60
65								9.5	9.1	9.1	9	8.5	65
70								8.5	8.2	8.1	7.9	7.5	70
75									7.5	7.2	7	6.6	75
80									6.8	6.4	6.3	5.9	80
85										5.8	5.6	5.2	85
90										5.2	5	4.6	90
95											4.5	4.1	95
100											4.1	3.6	100
105												3.2	105
110												2.8	110

n.v.* = over front · en avant

t_142_50001_00_001

Lifting capacities Forces de levage







T

    												
ft	27 ft	36 ft	45 ft	54 ft	63 ft	72 ft	82 ft	91 ft	100 ft	109 ft	118 ft	ft
10	83.8	83.4	80.9	67.4	65.3	55.2	43.8					10
11	78.5	78.2	75.9	67.8	64.7	55	43					11
12	73.7	72.7	69.1	65.9	61	54.7	42.1	34.3				12
13	68	68.6	63.8	60.2	56.5	52.1	41.1	34				13
14	62.7	62.6	58.3	54.6	51.9	48.2	40.2	33.6	26.6			14
15	58.2	56.6	53.2	50.8	47.5	44.2	39.2	33.3	27.2			15
16	52.7	51.4	48.7	46.8	43.7	40.7	37.9	33	26.9	20		16
17	46.7	46.9	45.4	43.1	40.5	37.7	35.3	32.5	26.6	22		17
18	41.8	42.9	42	39.9	37.6	35.1	33.7	31.8	26.3	21.8		18
19	37.7	39.2	39	37.2	35.1	32.8	32.2	30.2	26	21.5	17.2	19
20		36	36.4	34.7	32.8	31.4	30.2	28.4	25.7	21.3	17.2	20
22		30.6	31.4	30.6	29	28.5	26.9	25.3	24.4	20.8	17	22
24		26.3	27.2	27.2	26.7	25.6	24.2	23.6	22.2	20.2	16.8	24
26		23.1	23.9	24	24.3	23.1	21.9	21.4	20.2	19	16.6	26
28		20.4	21.2	21.8	22	21	20.6	19.6	18.4	17.4	16.3	28
30			18.9	19.7	19.7	19.2	18.9	17.9	16.9	16.4	15.7	30
32			17.1	17.8	17.8	17.6	17.4	16.5	16	15.5	14.7	32
34			15.5	16.2	16.2	16.4	16.1	15.2	14.9	14.4	13.5	34
36			14.2	14.8	14.8	15.1	14.9	14.3	13.8	13.3	12.6	36
38				13.6	13.7	13.9	13.7	13.5	12.9	12.4	11.7	38
40				12.6	12.6	12.8	12.6	12.6	12	11.6	10.9	40
45				10.5	10.5	10.7	10.5	10.2	10.1	9.8	9.1	45
50					8.9	9	8.8	8.6	8.4	8.2	7.7	50
55					7.6	7.7	7.6	7.4	7.2	7	6.6	55
60						6.7	6.5	6.4	6.2	6	5.6	60
65							5.7	5.6	5.3	5.1	4.7	65
70							4.9	4.9	4.6	4.4	4	70
75								4.2	3.9	3.8	3.4	75
80								3.7	3.4	3.3	2.9	80
85									2.9	2.8	2.4	85
90									2.5	2.3	2	90
95										2		95

t_142_00022_00_001

Lifting capacities Forces de levage





T

	 27 - 118 ft	 21 x 14.4 ft	 ±10° n.v.*	 14330 lbs	85%								
	 ft	27 ft	36 ft	45 ft	54 ft	63 ft	72 ft	82 ft	91 ft	100 ft	109 ft	118 ft	 ft
10		95.6	89.7	80.9	67.4	65.3	55.2	43.8					10
11		90.2	88.5	77.8	67.8	64.7	55	43					11
12		85.1	84.6	74.7	68.3	64.2	54.7	42.1	34.3				12
13		80.4	79.9	72	68.7	63.6	54	41.1	34				13
14		75.8	75.6	72.7	69.1	63.1	53.3	40.2	33.6	26.6			14
15		71.3	71.7	70.4	69.4	62.5	52.5	39.2	33.3	27.2			15
16		67.1	67.6	67.2	65.4	61.4	51.7	38.1	33	26.9	20		16
17		63.5	64	63.8	61.9	59.6	50.9	36.9	32.6	26.6	22		17
18		57.9	60.5	60.2	59.5	57.7	50.1	35.7	32.1	26.3	21.8		18
19		46.4	57.2	56.9	56.1	54.5	49.2	34.5	31.4	26	21.5	17.2	19
20			54	53.7	52.8	50.5	47.6	33.3	30.6	25.7	21.3	17.2	20
22			48.1	48.2	46.9	44.1	43.1	31.1	29	24.9	20.8	17	22
24			41.4	42	41.4	40.3	38.3	29.8	27.4	24.1	20.2	16.8	24
26			35.8	36.5	36.3	36.3	34.4	28.7	25.9	23.2	19.6	16.6	26
28			31.4	32.5	32.8	32.6	31.1	27.7	24.7	22.3	19	16.3	28
30				29.1	29.3	29.1	28.3	26.6	23.4	21.4	18.4	15.9	30
32				26.2	26.4	26.1	25.7	25.4	22.1	20.5	17.8	15.5	32
34				23.7	23.9	23.7	23.5	23.8	20.8	19.5	17.2	15.1	34
36				21.6	21.8	21.6	22.1	21.8	19.8	18.6	16.7	14.7	36
38					20	19.8	20.3	19.9	18.9	17.7	16.1	14.3	38
40					18.4	18.5	18.7	18.4	17.9	17.1	15.6	14	40
45					15.3	15.8	15.6	15.2	15.4	15.1	14.2	13	45
50						13.4	13.2	13.2	13.1	12.7	12.4	12.1	50
55						11.6	11.3	11.6	11.2	10.9	10.9	10.8	55
60							10.1	10.1	9.7	9.8	9.6	9.2	60
65								8.9	8.6	8.6	8.5	8	65
70								7.9	7.8	7.6	7.5	7	70
75									7	6.7	6.6	6.2	75
80									6.3	6	5.9	5.5	80
85										5.3	5.2	4.8	85
90										4.8	4.6	4.2	90
95											4.1	3.7	95
100											3.6	3.3	100
105												2.9	105
110												2.5	110

t_142_00002_00_001

Lifting capacities Forces de levage







T

    												
ft	27 ft	36 ft	45 ft	54 ft	63 ft	72 ft	82 ft	91 ft	100 ft	109 ft	118 ft	ft
10	44.3	39.4	36.3	33.4								10
11	39.8	36.4	32.9	30.6								11
12	35.5	33.8	30.8	28.2	25.8							12
13	32.1	31	28.9	27	24.9	23						13
14	28.8	28.3	27.3	24.8	22.9	21.1						14
15	25.8	25.9	25.2	24	22.6	20.8						15
16	23.2	23.9	23.3	22.7	21.5	20.1	18.4					16
17	21	22.1	21.6	21.4	20.5	19.2	17.9	15.9				17
18	19.2	20.4	20.1	20	19.2	18	16.8	14.9				18
19	17.5	18.9	18.8	18.8	18	16.9	16.6	15.5				19
20		17.4	17.6	17.6	16.9	16.5	15.7	14.6	12.8			20
22		15	15.6	15.7	15.1	14.7	14	13.5	12.7	11.8		22
24		13	13.7	14.1	13.5	13.2	12.7	12.2	11.4	10.9	10.1	24
26		11.4	12.1	12.7	12.2	12	11.5	11	10.3	9.8	9.1	26
28		10.1	10.7	11.4	11.1	10.9	10.4	10	9.4	8.9	8.2	28
30			9.6	10.1	9.9	10	9.5	9.1	8.5	8.1	7.4	30
32			8.6	9.1	9	9.1	8.7	8.4	7.8	7.4	6.8	32
34			7.8	8.3	8.1	8.3	7.9	7.7	7.1	6.8	6.1	34
36			7.1	7.6	7.4	7.6	7.3	7	6.5	6.2	5.6	36
38				6.9	6.8	7	6.7	6.5	6	5.7	5.1	38
40				6.4	6.3	6.4	6.2	6	5.5	5.2	4.6	40
45				5.2	5.1	5.3	5	4.9	4.4	4.1	3.6	45
50					4.2	4.3	4.1	4	3.5	3.3	2.8	50
55					3.4	3.6	3.4	3.3	2.8	2.6	2.1	55
60						2.9	2.8	2.7	2.3	2		60
65							2.2	2.2				65

t_142_00023_00_000

Lifting capacities Forces de levage

T





	 27 - 118 ft	 21 x 7.5 ft	 ±10° n.v.*	 14330 lbs	85%								
	 ft	27 ft	36 ft	45 ft	54 ft	63 ft	72 ft	82 ft	91 ft	100 ft	109 ft	118 ft	 ft
10		85.8	67.8	49.9	38.9	32.4	27.4	22.4					10
11		80.5	64.3	47.8	37.4	31.3	26.6	22.7					11
12		75.6	61.1	45.8	36	30.3	25.8	22.1	18.7				12
13		71.3	58.3	43.9	34.8	29.4	25.1	21.5	18.8				13
14		66.9	55.8	42.3	33.6	28.5	24.4	21	18.3	15.8			14
15		62.3	53.6	40.8	32.5	27.7	23.8	20.4	17.9	15.5			15
16		58.1	51.7	39.4	31.5	26.9	23.2	19.9	17.5	15.1	13.4		16
17		53.9	50	38.1	30.6	26.2	22.6	19.5	17.1	14.8	13.1		17
18		49.2	48.4	37	29.7	25.5	22	19	16.7	14.5	12.8		18
19		45.4	45.9	35.9	28.9	24.8	21.5	18.6	16.3	14.2	12.6	10.9	19
20			43.1	34.9	28.1	24.2	21	18.2	16	13.9	12.3	10.6	20
22			37.3	33.2	26.7	23.1	20.1	17.4	15.3	13.3	11.8	10.2	22
24			33.3	31.7	25.5	22	19.2	16.7	14.7	12.8	11.4	9.8	24
26			29.3	29.7	24.4	21.2	18.5	16	14.2	12.3	10.9	9.4	26
28			26.5	27.1	23.5	20.3	17.8	15.4	13.7	11.9	10.5	9.1	28
30				24.7	22.7	19.6	17.1	14.9	13.2	11.5	10.2	8.8	30
32				22.5	21.6	18.9	16.5	14.4	12.7	11.1	9.8	8.5	32
34				20.1	20.2	18.3	16	13.9	12.3	10.7	9.5	8.2	34
36				18.6	18.7	17.8	15.5	13.4	11.9	10.3	9.2	7.9	36
38					17.4	17.3	15.1	13	11.6	10	8.9	7.6	38
40					16.4	16.6	14.6	12.6	11.2	9.7	8.6	7.4	40
45					14.2	14.2	13.3	11.8	10.4	9	8	6.8	45
50						12.3	12.1	11.1	9.8	8.4	7.4	6.3	50
55						10.2	10.3	10.2	9.3	7.9	7	5.8	55
60							9.1	8.9	8.8	7.5	6.5	5.5	60
65								8	8	7.1	6.2	5.1	65
70								7.1	7.1	6.9	5.9	4.8	70
75									6.4	6.2	5.6	4.6	75
80										5.8	5.4	4.3	80
85											4.9	4.2	85
90											4.6	4	90
95												4	95
100												3.6	100
105													105
110													110

n.v.* = over front · en avant

t_142_00003_00_001

Lifting capacities Forces de levage

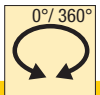
T

ft	27 ft			36 ft			45 ft			54 ft			ft
	0° *	0° **	360°	0° *	0° **	360°	0° *	0° **	360°	0° *	0° **	360°	
10		46.2			29			20.9			16.6		10
11	27	41.1			28.6			20.6			16.4		11
12	25.1	36.4			28.3			20.3			16.2		12
13	23.4	31.8			28			20.1			15.9		13
14	21.9	27.9			27.4			19.9			15.7		14
15	20.1	24.8		20.8	25.5			19.7			15.6		15
16	18.5	22.2	13.7	19.2	23			19.5			15.4		16
17	17.4	19.8	12.5	18.1	20.7			19.3			15.3		17
18	16.4	18	11.4	17.1	18.7		17.4	18.7			15.1		18
19	15.5	16.4	10.4	16.2	17.3		16.5	17.6			15		19
20				15.3	15.9		15.7	16.2		14.2	14.9		20
22				13.8	13.7	9.2	14.2	14		14.5	14.3		22
24				12.5	11.9	7.9	12.9	12.2	8.2	13.4	12.7		24
26				11.4	10.2	6.9	11.8	10.6	7.3	12.3	11.2	7	26
28				9.9	9	6	10.9	9.3	6.6	11.3	9.8	6.3	28
30							9.5	8.4	5.8	10.1	8.8	6.1	30
32							8.7	7.5	5.1	9.2	8	5.6	32
34							8.1	6.8	4.5	8.5	7.2	5.1	34
36							7.5	6.2	4	7.9	6.6	4.6	36
38										7.4	6	4.2	38
40										6.9	5.5	3.7	40
45										5.9	4.5	2.8	45

0° * = over front · en avant
0° ** = over rear · en arrière

Tyre size · dimensions de pneumatiques: 385/95 R 25 (14.00 R 25)

t_142_00033_00_000 / 00031_00_000 / 00035_00_000

Lifting heights Hauteurs de levage

T

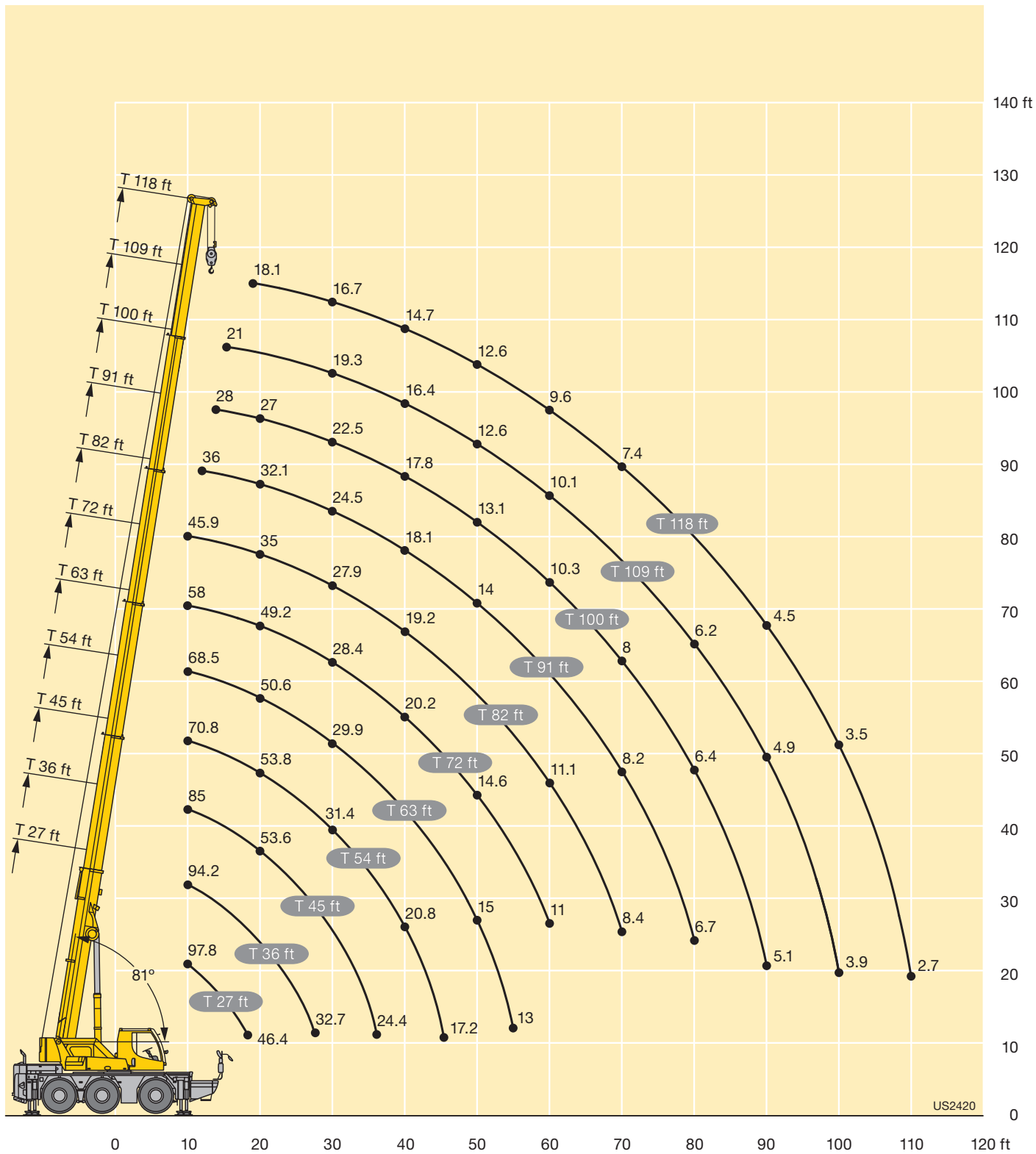

Telescopic loads Capacités de levage en télescopage

T

	T-27 ft	T-36 ft	T-45 ft	T-45 ft	T-54 ft	T-63 ft	T-63 ft	T-72 ft	T-82 ft	T-82 ft	T-91 ft	T-100 ft	T-100 ft	T-109 ft	T-118 ft
Tele 1	0%	0%	0%	0%	0%	0%	0%	0%	0%	0%	0%	0%	0%	0%	0%
Tele 2	0%	0%	0%	0%	0%	0%	0%	0%	0%	0%	0%	0%	0%	0%	0%
Tele 3	0%	0%	0%	0%	0%	0%	0%	0%	0%	0%	0%	0%	0%	0%	0%
Tele 4	0%	0%	0%	0%	0%	0%	0%	0%	0%	0%	0%	0%	0%	0%	0%
Tele 5	0%	0%	0%	0%	0%	0%	0%	0%	0%	0%	0%	0%	0%	0%	0%
∠															
70°			26.9	36.2	34.4	19.8	24.7	24.7	16.1	18.7	17.9	13.2	16.8	15.9	11
60°		50.3	24	27.1	26.2	16.5	17.6	17.6	12.8	13.7	13.2	9.3	12.3	12.1	7.3
50°	78.5	42.3	21.8	21.8	21.4	14.6	14.1	14.1	10.6	10.6	10.6	7.5	9.3	8.6	5.5
40°	71	37.5	18.5	18.5	18.1	13	11.7	11.7	8.6	8.6	8.6	5.7	7.5	6.2	3.5
30°	61.7	35.1	16.8	16.8	16.3	11.5	10.1	10.1	7.3	7.5	7.5	4.2	6	4.9	2.2
20°	55.3	33.7	15.9	15.9	15.2	10.4	9.3	9.3	6.2	7.1	6.4	3.5	5.1	4	
10°	43.9	30.9	15.4	15.4	15	9.3	9	9	5.3	6.8	6	2.9	4.6	3.5	
0°	30	20.9	15.4	15.4	13.2	8.8	9	8.6	5.1	6.8	6	2.6	4.4	3.5	

	T-27 ft	T-36 ft	T-45 ft	T-45 ft	T-54 ft	T-63 ft	T-63 ft	T-72 ft	T-72 ft	T-82 ft	T-82 ft	T-91 ft	T-100 ft
Tele 1	0%	0%	0%	0%	0%	0%	0%	0%	0%	0%	0%	0%	0%
Tele 2	0%	0%	0%	0%	0%	0%	0%	0%	0%	0%	0%	0%	0%
Tele 3	0%	0%	0%	0%	0%	0%	0%	0%	0%	0%	0%	0%	0%
Tele 4	0%	0%	0%	0%	0%	0%	0%	0%	0%	0%	0%	0%	0%
Tele 5	0%	0%	0%	0%	0%	0%	0%	0%	0%	0%	0%	0%	0%
∠													
70°			26.9	36.2	34.4	19.8	24.7	24.7	24.9	24	24	23.1	13.2
60°		50.3	24	27.1	26.2	16.5	17.6	17.6	17.9	17.4	17.4	17	9
50°	78.5	42.3	21.8	21.8	21.4	14.6	14.1	14.1	14.3	14.1	14.1	12.1	7.5
40°	71	37.5	18.5	18.5	18.1	13	11.7	11.7	12.1	11	11	8.8	5.7
30°	61.7	35.1	16.8	16.8	16.3	11.5	10.1	10.1	11	9	9	7.1	4.2
20°	55.3	33.7	15.9	15.9	15.2	10.4	9.3	9.3	9.9	7.9	7.9	6.2	3.3
10°	43.9	30.9	15.4	15.4	15	9.3	9	9	9.3	7.3	7.3	5.5	2.6
0°	30	20.9	15.4	15.4	13.2	8.8	9	8.6	8.6	7.3	7.3	5.5	2.4

	T-27 ft	T-36 ft	T-45 ft	T-45 ft	T-54 ft	T-54 ft	T-63 ft	T-63 ft	T-72 ft	T-72 ft	T-82 ft	T-91 ft
Tele 1	0%	0%	0%	0%	0%	0%	0%	0%	0%	0%	0%	0%
Tele 2	0%	0%	0%	0%	0%	0%	0%	0%	0%	0%	0%	0%
Tele 3	0%	0%	0%	0%	0%	0%	0%	0%	0%	0%	0%	0%
Tele 4	0%	0%	0%	0%	0%	0%	0%	0%	0%	0%	0%	0%
Tele 5	0%	0%	0%	0%	0%	0%	0%	0%	0%	0%	0%	0%
∠												
70°			26.9	36.2	34.4	34.4	33.1	33.1	32.2	32.2	30.6	14.6
60°		50.3	24	27.1	26.2	26.2	25.6	25.6	24.9	24.9	22.5	11
50°	78.5	42.3	21.8	21.8	21.4	21.4	20.9	20.9	18.1	18.1	14.3	8.4
40°	71	37.5	18.5	18.5	18.1	18.1	17.4	17.4	13.4	13.4	10.6	7.1
30°	61.7	35.1	16.8	16.8	16.3	16.3	14.1	14.1	11	11	8.4	5.3
20°	55.3	33.7	15.9	15.9	15.2	15.2	12.3	12.3	9.5	9.5	7.3	4.2
10°	43.9	30.9	15.4	15.4	15	15	11.7	11.7	8.8	8.8	6.8	3.5
0°	30	20.9	15.4	15.4	13.2	13.2	10.1	10.1	8.4	8.4	6.6	3.1

Telescopic loads Capacités de levage en télescopage

T

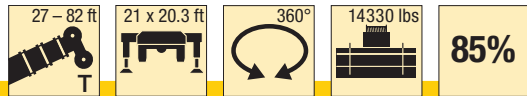

	T-27 ft	T-36 ft	T-36 ft	T-45 ft	T-45 ft	T-54 ft	T-54 ft	T-63 ft	T-63 ft	T-72 ft	T-82 ft
Tele 1	0%	0%	0%	0%	0%	0%	0%	0%	0%	0% → 50%	100%
Tele 2	0%	0%	0%	0%	0%	0%	0%	0% → 50%	50%	50%	50%
Tele 3	0%	0%	0%	0%	0%	0%	50%	50%	50%	50%	50%
Tele 4	0%	0%	0%	50%	50%	50%	50%	50%	50%	50%	50%
Tele 5	0%	50%	50%	50%	50%	50%	50%	50%	50%	50%	50%
∠											
70°				56	59.3	51.8	55.3	46.7	51.6	43	15.7
60°		50.3	50.3	47.4	47.4	40.8	40.8	35.9	35.9	27.3	12.3
50°	78.5	42.3	42.3	38.6	38.6	30.9	30.9	22.7	22.7	17.2	9.3
40°	71	37.5	37.5	31.7	31.7	22.3	22.3	16.5	16.5	12.6	8.4
30°	61.7	35.1	35.1	25.6	25.6	18.1	18.1	13.4	13.4	10.1	6.4
20°	55.3	33.7	33.7	22	22	15.9	15.9	11.7	11.7	8.8	5.1
10°	43.9	30.9	30.9	20.7	20.7	14.8	14.8	10.8	10.8	8.2	4.2
0°	30	20.9	20.9	16.1	16.1	12.8	12.8	9.7	9.7	7.7	3.7

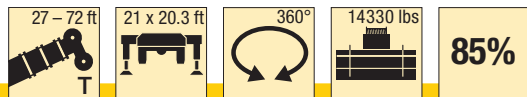

	T-27 ft	T-36 ft	T-36 ft	T-45 ft	T-45 ft	T-54 ft	T-54 ft	T-63 ft	T-72 ft
Tele 1	0%	0%	0%	0%	0%	0%	0%	0%	0%
Tele 2	0%	0%	0%	0%	0%	0%	50%	50%	50%
Tele 3	0%	0%	0%	0%	50%	50%	50%	50%	50%
Tele 4	0%	50%	50%	50%	50%	50%	50%	50%	50%
Tele 5	0%	0%	0%	0%	0%	0%	0%	0%	0%
∠									
70°				55.3	58.9	49.6	55.1	45.4	17.4
60°		61.3	64.2	53.6	56.2	47	47.2	34.6	13.9
50°	77.2	60	60	43.2	43.2	30	30	21.6	11.7
40°	71	47.2	47.2	31.1	31.1	21.4	21.4	15.7	9.5
30°	61.7	39	39	24.7	24.7	17.2	17.2	12.6	8.2
20°	55.3	33.7	33.7	21.4	21.4	15	15	10.8	6.4
10°	43.9	30.4	30.4	20.1	20.1	13.9	13.9	9.9	5.5
0°	30	20.5	20.5	15.7	15.7	12.3	12.3	9	4.9

Lifting heights - Telescopic loads

Hauteurs de levage - Capacités de levage en télescopage

T

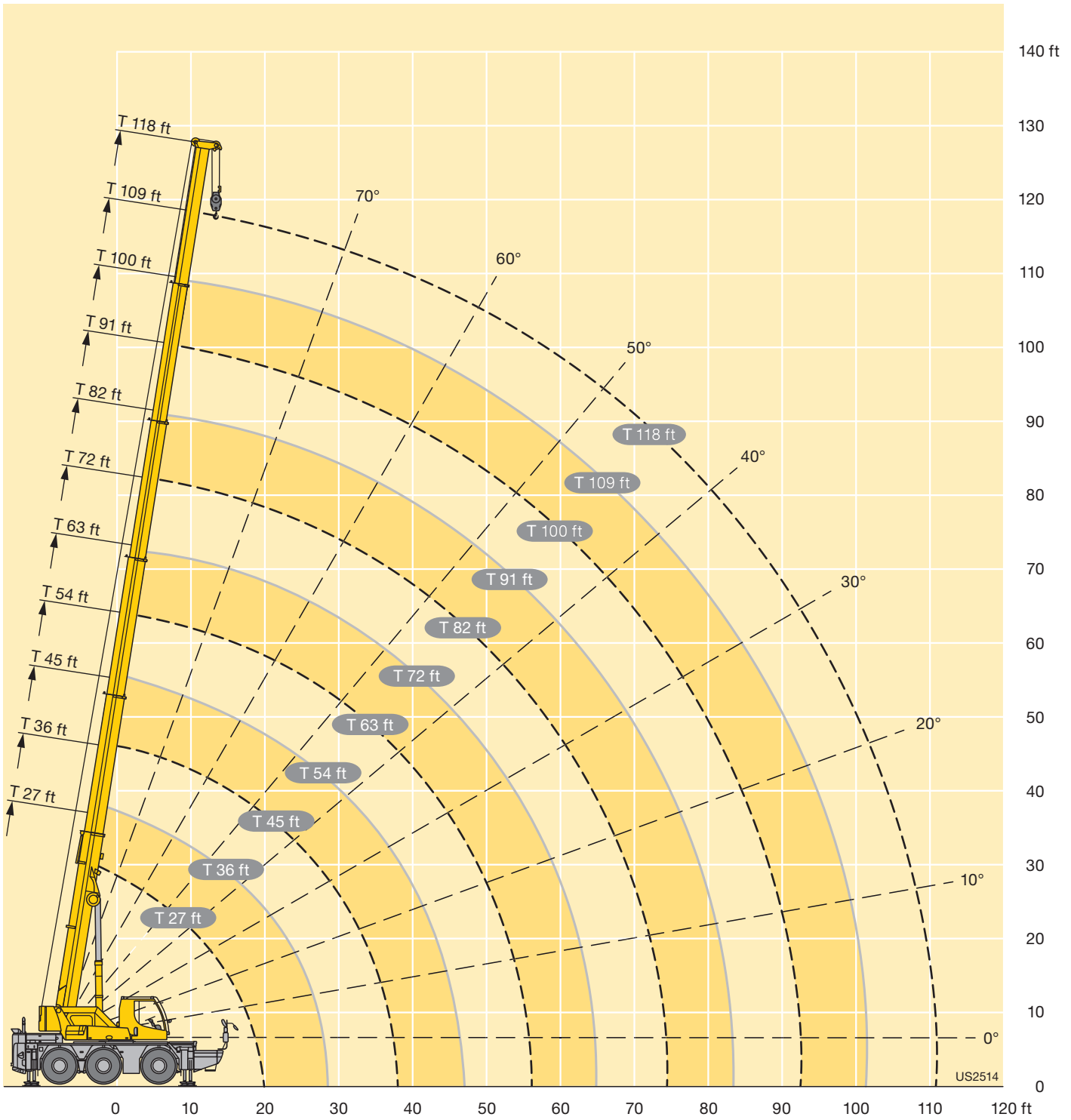

Lifting capacities Forces de levage



ft	27 ft				36 ft				45 ft				54 ft				63 ft				72 ft				ft				
	5 ft				5 ft				5 ft				5 ft				5 ft				5 ft								
	0°	20°	40°	60°	0°	20°	40°	60°	0°	20°	40°	60°	0°	20°	40°	60°	0°	20°	40°	60°	0°	20°	40°	60°		0°	20°	40°	60°
10		55.1	49.1	37.7			51	38.4			51.8	38.8			51.6	38.9			38.6										10
11		55.1	48.5	37.4			50.3	38.1			51.2	38.5			51.1	38.6			38.4										11
12		55.1	47.9	37.3			49.7	37.8			50.6	38.3			50.6	38.3			49.6	38.1							37.4		12
13		55.1	47.3	37.1			49.1	37.6			50.1	38			50.1	38.1			49.2	37.9							37.2		13
14		55.1	46.9	37			48.6	37.4			49.5	37.7			49.6	37.8			48.8	37.7							37.1		14
15		55.1	46.5	36.8		55.1	48.1	37.2			48.9	37.5			49.1	37.6			48.3	37.4						43.5	36.9		15
16	55.1	55	46.2	36.7		55.1	47.6	37			48.4	37.3			48.7	37.4			47.9	37.2						42.6	36.5		16
17	55.1	54.7	45.9	36.5		55.1	47.1	36.8			48	37.1			48.2	37.2			47.5	37						41.7	35.9		17
18	55.1	54.2	45.7	36.4		55.1	46.6	36.7			47.5	36.9			47.7	37			47.1	36.8						40.9	35.6		18
19	55.1	53.7	45.6	36.2		55.1	46.3	36.7			47.2	36.8			47.3	36.8			46.7	36.6						40	35.2		19
20	52.8	52.5	45.6	36		53.2	46	36.6		52.7	46.8	36.6			46.8	36.6			45.9	36.4						39.2	34.8		20
22	47.3	47.9	45.6	35.5		48.1	45.4	36.6		46.8	46	36.3			44.9	36.3			43.1	36.1						37.5	33.9		22
24		39.9	42.4	35.5	42.4	43	42.8	36.3		41.4	41.7	36.2			40.4	36.1			38.1	35.8						36.1	32.7		24
26					38.2	38.5	38.8	35.9		37.6	37.7	36.2			35.7	36.1	35.6		34	34.1						33.4	31.5		26
28					34.7	35	35.1	34.9		33.9	34.2	34.1			32.1	32.5	32.8		31.4	31.1						30.2	30		28
30					31.1	31.2	31.5	31.5		30.5	30.7	31	31.3			29.9	29.4	29.7		28.8	29	28.4				27.4	27.8		30
32					28.3	28.5	28.6	28.7		28.5	28	28.3	28.5			27.6	27.2	27.1		26.3	26.5	26.8				25.1	25.4		32
34										26.3	25.7	25.9	26.1			25.4	25.6	25.3		24.2	24.4	24.6				23	23.3		34
36										24	24.2	23.8	23.8			23.5	23.7	23.8		22.3	22.5	22.7				21.1	21.3	21.5	36
38										22	22.2	22.2	21.9	21.5	21.8	21.9	22.1		20.7	20.9	21.1				19.6	19.7	19.9	38	
40										20.1	20.3	20.3	20.4	19.8	20.2	20.2	20.4		19.3	19.4	19.6				18.2	18.3	18.5	40	
45														16.5	16.6	16.7	16.8		16	16.2	16.3	16.4				16.3	16.1	15.7	45
50														14	14	14.1	14.1		14.2	14.1	13.8	13.8				14	14.1	14.1	50
55																			12.2	12.3	12.3	12.4			11.8	12	12.1	12.1	55
60																			10.7	10.7	10.7				9.9	10	10.1	10.2	60
65																									8.6	8.7	8.7	8.8	65
70																									8	8			70

t_142_51301_00_000 / 51302_00_000 / 51303_00_000 / 51304_00_000

Lifting capacities Forces de levage

THK

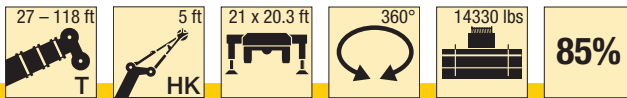

ft	82 ft				91 ft				100 ft				109 ft				118 ft				ft
	5 ft				5 ft				5 ft				5 ft				5 ft				
	0°	20°	40°	60°	0°	20°	40°	60°	0°	20°	40°	60°	0°	20°	40°	60°	0°	20°	40°	60°	
14				29.4																	14
15				35.2																	15
16				34.9																	16
17			31.7	34.7					30.3												17
18			35.2	34.4					29.8												18
19			34.2	33.8					29.2			25									19
20			33.1	32.8			28.9	28.5			24.7										20
22			31.1	30.7			27.7	27.3			23.8				19.6						22
24			29	28.7			26.4	26.1			23.2	22.9			19					16.1	24
26			27.3	27.2			25.2	24.9			22.2	21.9			18.4	18.4				15.8	26
28			25.8	25.8			23.9	23.8			21.1	20.9			17.8	17.8				15.4	28
30			24.3	24.5			22.8	22.6			20	19.8			17.3	17.2			14.9	15	30
32			22.8	23.2			21.7	21.4			19	18.8			16.7	16.6			14.5	14.6	32
34			21.3	21.8			20.7	20.2			18.3	18.1			16.2	16.1			14.1	14.2	34
36			20	20.3			19.6	19.1			17.6	17.4			15.6	15.5			13.7	13.8	36
38			19.1	18.7			18.5	18.4			16.9	16.8			15.1	15.1			13.3	13.4	38
40		18.1	18.2	17.8			17.3	17.4			16.1	16.1			14.6	14.6			12.9	12.9	40
45		15.3	15.5	15.5			14.5	14.6			14.4	14.4			13.5	13.4			11.9	11.8	45
50		13.1	13.2	13.3		12.9	13	13			12.3	12.4			11.6	11.7			10.8	10.7	50
55		11.3	11.4	11.4		11.2	11.3	11.3		10.4	10.6	10.6			10.2	10.1			9.8	9.9	55
60	10	10	10	10.1		9.6	9.6	9.7		9	9.1	9.2		9.1	9.1	9.1			8.6	8.7	60
65	8.7	8.8	8.8	8.8		8.3	8.4	8.4		8.1	8.3	8.2		8	8.1	8.1		7.4	7.5	7.5	65
70	7.6	7.7	7.7	7.7	7.2	7.2	7.3	7.3		7.3	7.3	7.3		7	7.1	7.1		6.4	6.5	6.5	70
75	6.8	6.8	6.8	6.8	6.6	6.6	6.7	6.6	6.3	6.4	6.4	6.5		6.2	6.2	6.2		5.6	5.7	5.7	75
80					5.9	5.9	6	5.9	5.5	5.6	5.7	5.6		5.4	5.4	5.4		4.9	4.9	4.9	80
85					5.3	5.3	5.3		4.9	5	5	5	4.7	4.7	4.8	4.8		4.3	4.3	4.3	85
90									4.3	4.4	4.4	4.3	4.1	4.1	4.2	4.1	3.6	3.7	3.7	3.7	90
95									3.7	3.8	3.8		3.5	3.6	3.6	3.6	3.1	3.2	3.2	3.2	95
100													3	3.1	3.1	3	2.6	2.7	2.7	2.6	100
105													2.6	2.6	2.6		2.1	2.2	2.2	2.2	105
110																	1.7	1.8	1.8	1.8	110
115																	1.4	1.4	1.4		115

t_142_51301_00_000 / 51302_00_000 / 51303_00_000 / 51304_00_000

Lifting heights Hauteurs de levage

THK

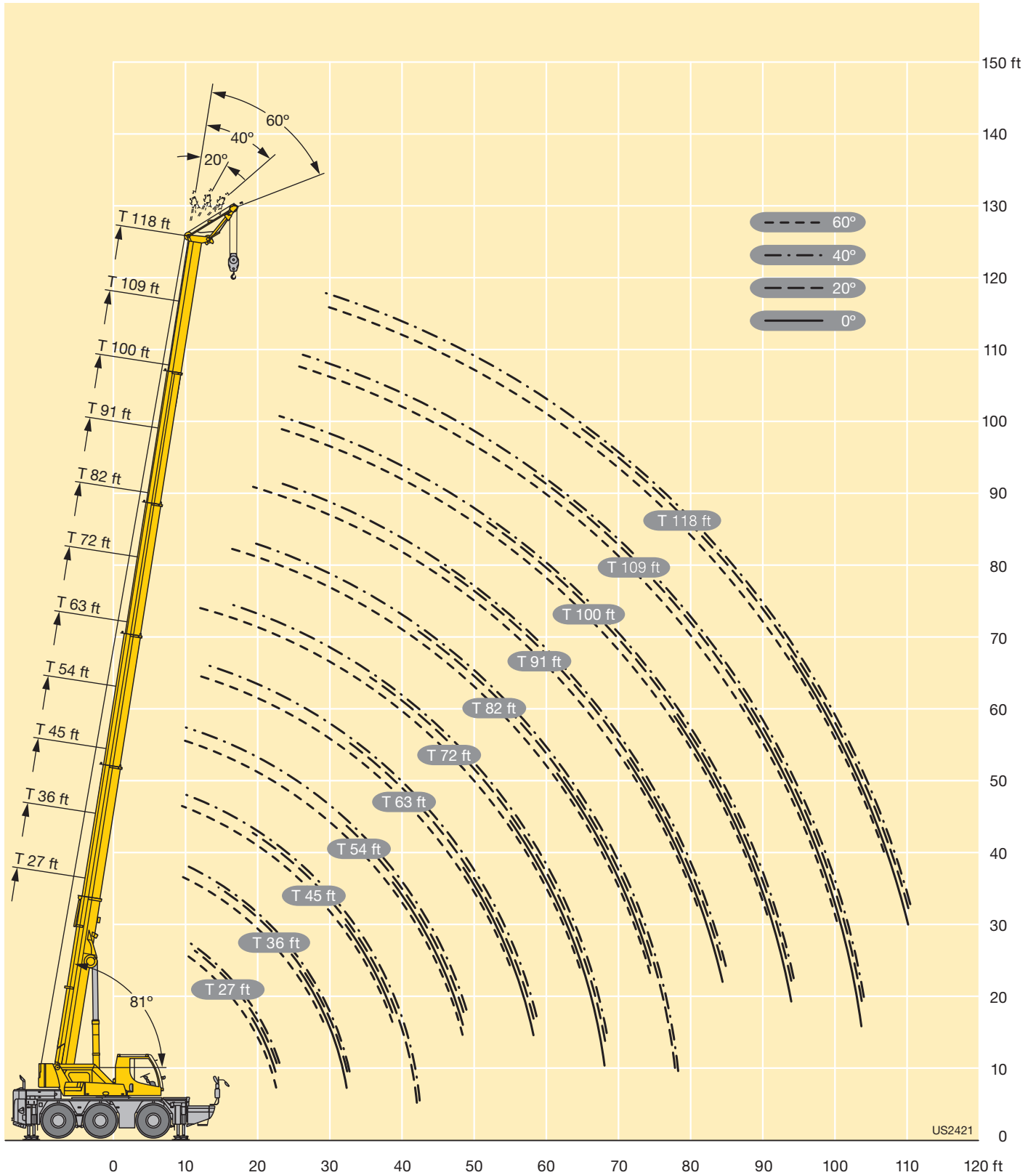

Lifting capacities Forces de levage

TK



ft	27 ft				91 ft				100 ft				109 ft				118 ft				ft	
	25 ft				25 ft				25 ft				25 ft				25 ft					
	0°	20°	40°	60°	0°	20°	40°	60°	0°	20°	40°	60°	0°	20°	40°	60°	0°	20°	40°	60°		
10	15.7																				10	
11	15.2	12.2																				11
12	14.8	12.2																				12
13	14.4	12.1																				13
14	13.9	11.8																				14
15	13.5	11.6																				15
16	13.2	11.3			19.3																	16
17	12.8	11			19.1																	17
18	12.4	10.7	8.5		18.9				16.6													18
19	12.1	10.3	8.5		18.6				16.6													19
20	11.7	10	8.4		18.4				16.5													20
22	10.9	9.6	8.1	6.1	18				16.3				14.1									22
24	10.1	9.3	7.9	6	17.6	12.8			16.1				14.1				11.7					24
26	9.2	9	7.8	5.9	17.1	12.6			15.9				14				11.5					26
28	8.4	8.7	7.6	5.6	16.7	12.4			15.6	12.1			13.9				11.3					28
30	7.9	8.4	7.5		16.3	12.2			15.3	11.9			13.7	11.3			11.1					30
32	7.5	8.1	7.2		15.9	12	8.9		15	11.6			13.4	11			10.9					32
34	7	7.6	7.1		15.5	11.7	8.8	6.4	14.8	11.3	8.8		13.1	10.6			10.7	9.9				34
36	6.6	7.1	4		15.2	11.4	8.7	6.3	14.4	10.9	8.8		12.9	10.4	8.6		10.4	9.7				36
38	6.3	6.7	1.3		14.8	11	8.6	6.3	14.1	10.6	8.6	6.3	12.6	10.2	8.5		10.2	9.5				38
40	5.9	6.3	1.3		14.4	10.7	8.5	6.3	13.7	10.4	8.6	6.2	12.3	10.1	8.4	6.2	10	9.3	8.1			40
45					13.4	10.2	8.3		12.8	10.1	8.4	6.2	11.2	9.8	8.2	6.1	9.5	8.7	7.9	6.1		45
50					11.8	9.8	8.2		11.4	9.8	8.2		10.1	9.4	8.1		8.9	8.3	7.6	6		50
55					10.4	9.6	8		10	9.5	8.1		9.4	8.9	7.9		8.3	7.8	7.3			55
60					9.1	9.1	7.8		8.9	9	7.9		8.3	8.4	7.8		7.8	7.4	7.1			60
65					8.3	8.4	7.6		7.8	7.9	7.8		7.3	7.7	7.6		7.2	7	6.8			65
70					7.5	7.4	7.5		6.8	7.3	7.3		6.7	6.8	7.1		6.3	6.6	6.5			70
75					6.6	6.9			6.2	6.4	6.8		6	6.2	6.3		5.4	6	6.2			75
80					5.9	6.2			5.6	5.7			5.3	5.7	5.8		4.7	5.2	5.6			80
85					5.2	5.4			5	5.2			4.7	5.1			4.1	4.6	4.9			85
90					4.7	4.8			4.5	4.8			4.1	4.5			3.5	4				90
95					4.3				3.9	4.2			3.6	3.9			3	3.4				95
100					3.8				3.4	3.6			3.1	3.4			2.6	3				100
105									2.9				2.7	2.9			2.2	2.5				105
110									2.5				2.3				1.8	2.1				110
115													1.9				1.5	1.7				115
120													1.5									120

t_142_52301_00_000 / 52302_00_000 / 52303_00_000 / 52304_00_000

Lifting capacities Forces de levage

TK



ft	27 ft				91 ft				100 ft				109 ft				118 ft				ft
	43 ft				43 ft				43 ft				43 ft				43 ft				
	0°	20°	40°	60°	0°	20°	40°	60°	0°	20°	40°	60°	0°	20°	40°	60°	0°	20°	40°	60°	
10	9																				10
11	8.7																				11
12	8.5																				12
13	8.2																				13
14	7.9																				14
15	7.6																				15
16	7.4																				16
17	7.2																				17
18	7				11.1																18
19	6.8	5.6			10.9																19
20	6.6	5.6			10.6				9.8												20
22	6.3	5.4			10.1				9.5				8.7								22
24	6	5.2			9.7				9.2				8.5								24
26	5.7	5			9.3				8.9				8.4				7.3				26
28	5.4	4.8			9				8.6				8.2				7.3				28
30	5.1	4.6			8.7				8.4				8.1				7.2				30
32	4.9	4.4	3.8		8.3	5.9			8.1				7.9				7.1				32
34	4.7	4.3	3.8		8	5.8			7.9				7.7				7				34
36	4.5	4.1	3.7		7.8	5.6			7.7	5.6			7.5				6.9				36
38	4.4	4	3.6		7.6	5.5			7.5	5.5			7.4	5.3			6.8				38
40	4.2	3.9	3.5	3.1	7.4	5.4			7.3	5.4			7.2	5.2			6.7				40
45	3.8	3.6	3.3	3	6.8	5.1	4		6.9	5.1			6.8	5			6.4	4.9			45
50	3.6	3.4	3.2	1.4	6.3	4.9	3.9		6.4	4.9	3.9		6.4	4.8	3.8		6.1	4.7			50
55	3.3	3.3	1.5	1.4	6	4.6	3.8	3.2	6.1	4.7	3.8	3.2	6.1	4.6	3.8		5.8	4.5	3.7		55
60	3.2	1.7			5.6	4.5	3.7	3.2	5.8	4.5	3.7	3.2	5.8	4.4	3.7	3.2	5.6	4.4	3.6	3.1	60
65					5.2	4.3	3.6		5.5	4.3	3.6		5.5	4.3	3.6	3.1	5.3	4.2	3.5	3.1	65
70					5	4.1	3.5		5.2	4.2	3.5		5.3	4.2	3.5		5.1	4.1	3.5		70
75					4.7	4	3.5		4.9	4	3.5		5	4	3.5		4.9	4	3.4		75
80					4.5	3.9	3.4		4.7	3.9	3.4		4.8	3.9	3.4		4.7	3.9	3.4		80
85					4.3	3.7	3.4		4.5	3.8	3.4		4.5	3.8	3.4		4.3	3.8	3.3		85
90					4.1	3.6			4.2	3.7	3.4		4.2	3.7	3.3		3.7	3.7	3.3		90
95					3.9	3.6			4.1	3.6			3.8	3.6	3.3		3.2	3.6	3.3		95
100					3.8	3.5			3.7	3.5			3.3	3.5			2.8	3.3	3.3		100
105					3.6	3.4			3.3	3.4			2.9	3.3			2.4	2.9			105
110					3.2				2.9	3.2			2.5	2.9			2	2.5			110
115					2.8				2.5	2.8			2.2	2.5			1.7	2.1			115
120					2.5				2.1				1.8	2.2			1.4	1.8			120
125									1.8				1.5				1.4				125
130									1.5				1.2								130

t_142_53301_00_000 / 53302_00_000 / 53303_00_000 / 53304_00_000

Lifting heights Hauteurs de levage

TK

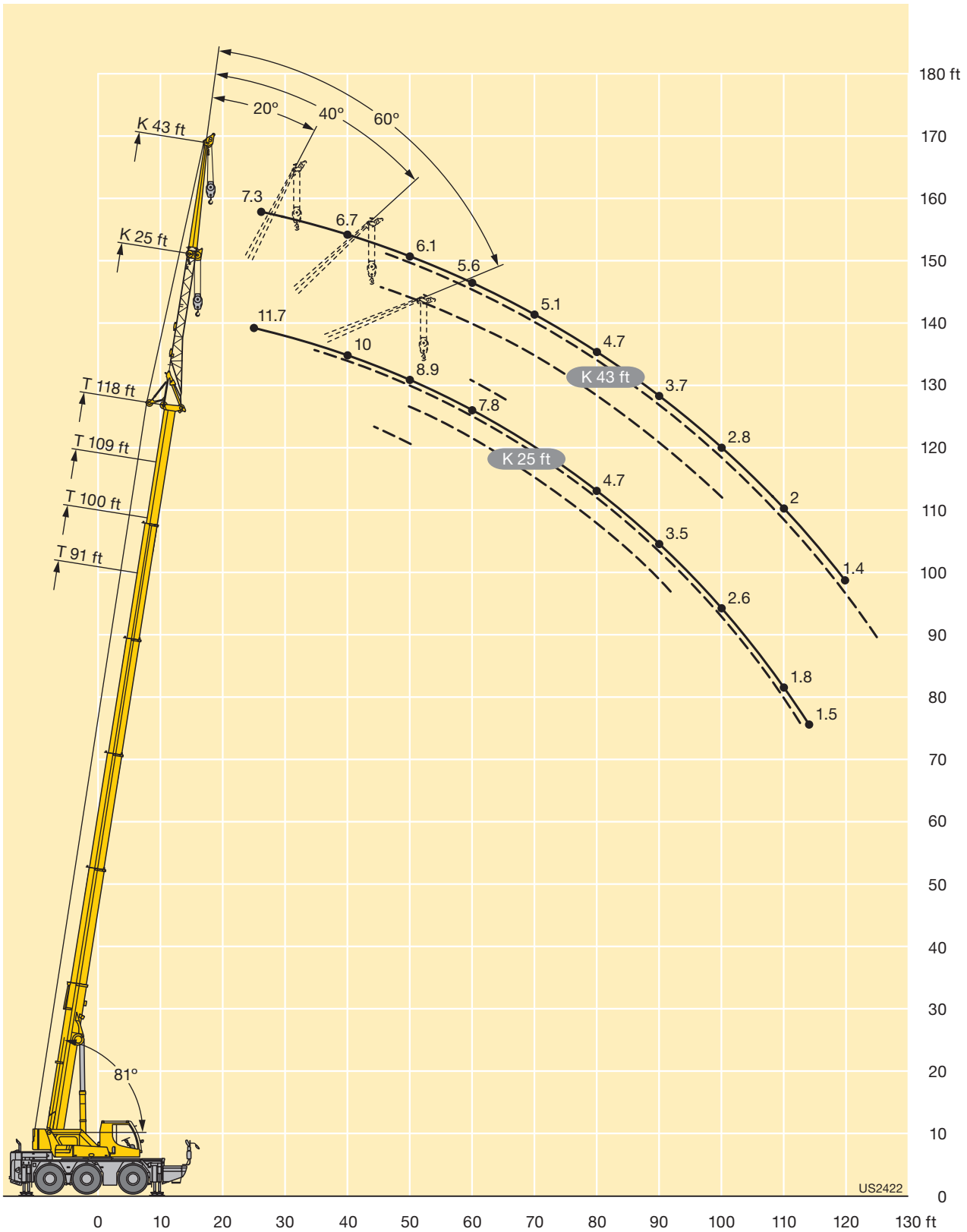

Equipment Equipement

Crane carrier

Chassis	Self-manufactured, torsion-resistant box-type design of high-tensile grain refined structural steel.
Outriggers	4-point supporting system, hydraulically telescopic into horizontal and vertical direction. Operation with remote control, automatic support leveling, electronic inclination display.
Engine	Diesel, 6 cylinder, watercooled, make Mercedes-Benz, output 240 kW (326 h.p.), max. torque 959 lbs-ft. Exhaust emissions acc. to 97/68/EG and EPA/CARB. Fuel tank capacity: 79 gallons.
Gearbox	ZF powershift gearbox with torque converter, lock-up clutch and integrated distribution gearbox with longitudinal differential.
Axles	All axles steered, axles 1 and 3 driven with transverse differential locks.
Suspension	All axles on hydro-pneumatic suspension and lockable hydraulically.
Tyre equipment	6-fold, tyre size: 385/95 R 25 (14.00 R 25)
Steering	2-circuit system with hydraulic servo steering. Active speed depending rear axle steering, special steering programs for various driving situations.
Brakes	Service brake: all-wheel servo-air brake, all axles are equipped with disc brakes, dual circuit. Hand brake: Spring-loaded, acting on all wheels of axles 2 and 3. Sustained-action brake: Exhaust retarder. Anti-lock device.
Electric system	Control of the electric and electronic components by modern data bus technology, 24 Volt direct current, 2 batteries of 170 Ah each.
Toolbox	Detachable storage box at the front of chassis.

Crane superstructure

Superstructure	Self-manufactured, torsion-resistant welded design of high-tensile grain refined structural steel. The superstructure is connected with the carrier by a single-row ball bearing slewing ring which enables continuous rotation.
Crane drive	Diesel-hydraulic with 1 variable axial piston pump in open circuit, 1 gear type twin pump driven by the diesel engine of the carrier, 4 working movements simultaneously drivable.

Control	By selfcentering four directional joysticks in the crane cabin and by varying the speed of the diesel engine, electronic precontrol and stepless regulation of all crane movements.
Hoist gear	Axial piston constant motor, Liebherr rope winch with installed planetary gear and spring loaded, hydraulically releasing holding brake.
Luffing gear	1 differential double ram with safety check valves and hydraulic compensation circuit.
Slewing gear	Axial piston fixed displacement motor, Liebherr planetary gear, spring loaded hydraulically releasing holding brake.
Driver's and crane operator's cab	Steel plate execution, cataphoretic dip primer, rubber-elastically supported, with safety glazing, Operating and control elements for displacement and crane operation, comfortably equipped, air-conditioning system. For improved visibility cab slidable by telescopic arm and automatically lockable with chassis.
Safety devices	LICCON2 safe load indicator, hoist limit switch, safety valves against pipe and hose rupture, test system for servicing.
Telescopic boom	Buckling and torsion resistant design of high-tensile grain refined structural steel with oviform profile, 1 base section and 5 boom sections. All boom sections hydraulically extendable separately by the rapid-cycle telescoping system TELEMATIK. Boom length: 27 ft – 118 ft.
Counterweight	14330 lbs basic counterweight firmly mounted.
Electric system	Control of the electric and electronic components by the latest data bus technology.

Optional equipment

Single / double swing-away jib	25 ft – 43 ft long, mountable at 0°, 20°, 40° and 60° to the telescopic boom.
Erection jib	5 ft long and incorporated into the swing-away jib, mountable at 0°, 20°, 40° and 60°.
Pulley set / hook for erection jib	3 rope pulleys for a max. load capacity of 55115 lbs. Single hook for max. 55115 lbs load capacity.
Driver's and crane operator's cab	Lifting of the cab by the telescopic arm.
2nd hoist gear	For 2-hook operation or at operation with swing-away jib, if the main hoist rope shall remain reeved.
Tyres	6 tyres. Tyre size: 445/95 R 25 (16.00 R 25).
Drive 6 x 6	Additionally the second axle can be activated in off road operation.
Additional brake	Telma Eddy currant brake at the 2 nd axle.

Further optional equipment available on request.

Equipment Equipment

Châssis porteur

Châssis	Structure en caisson résistante à la torsion, fabriquée par Liebherr, en acier à grain fin très résistant.
Stabilisateurs	Dispositif de calage horizontal et vertical en 4 points, entièrement déployable hydrauliquement. Utilisation avec commande à distance, mise à niveau automatique du calage, inclinomètre électronique.
Moteur	Diesel, 6 cylindres, marque Mercedes-Benz, refroidissement par eau, puissance 240 kW (326 ch), couple max. 959 lbs-ft. Emissions des gaz d'échappement conformes aux directives 97/68/EG et EPA/CARB. Capacité du réservoir carburant: 79 gallons.
Boîte	Boîte de vitesse ZF avec convertisseur de couple, embrayage lock-up et boîte de transfert intégrée avec différentiel longitudinal.
Essieux	Tous les essieux sont directeurs, les essieux 1 et 3 sont entraînés avec blocages des différentiels transversaux.
Suspension	Tous les essieux sont suspendus hydro-pneumatiquement et peuvent être bloqués hydrauliquement.
Pneumatiques	6 fois, dimension de pneumatiques : 385/95 R 25 (14.00 R 25)
Direction	2 circuits avec direction assistée hydraulique. Direction active des essieux arrière et dépendante de la vitesse, programmes de direction spéciaux pour les différents modes de déplacement.
Freins	Freins de service: servofrein à air comprimé, tous les essieux sont munis de freins à disque, à 2 circuits. Frein à main: par cylindres à ressorts, agissant sur les roues des essieux 2 et 3. Frein à régime continu: Ralentisseur sur échappement. Dispositif anti-enrayeur.
Circuit électrique	Technologie de bus de données moderne pour la commande des composants électriques et électroniques, courant continu 24 Volts, 2 batteries de 170 Ah chacune, éclairage conforme au code de la route allemand.
Caisse à outils	Coffre de rangement amovible sur la partie avant du véhicule.

Partie tournante

Partie tournante	Structure soudée de fabrication Liebherr, résistante à la torsion, en acier à grains fins très résistant. Une couronne d'orientation à un rangé de billes sert de lien avec le châssis porteur et permet une rotation illimitée.
Entraînement	Diesel-hydraulique avec 1 pompe à débit variable et pistons axiaux dans un circuit hydraulique ouvert, 1 double pompe à engrenages entraînée par le moteur Diesel dans le châssis porteur, 4 mouvements de travail pouvant être exécutés simultanément.

Commande	Commande dans la cabine du grutier via 4 manipulateurs à retour automatique en position neutre et régulation du régime du moteur diesel, servocommande électronique et régulation continue de tous les mouvements de la grue.
Treuil de levage	Moteur à débit constant et pistons axiaux, treuils Liebherr avec réducteur planétaire intégré et le frein d'arrêt à ressort à desserrage hydraulique.
Mécanisme de relevage	1 vérins différentiels double avec clapet de sécurité anti-retour et conduite de compensation hydraulique.
Mécanisme d'orientation	Moteur à cylindrée constante et à pistons axiaux, réducteur planétaire Liebherr, frein d'arrêt à ressort à desserrage hydraulique.
Cabine conducteur / du grutier	Cabine en tôle électrozinguée par bain de cataphorèse, montée sur silentbloc en caoutchouc et dotée de vitres de sécurité, instruments de commande et de contrôle pour la translation et l'utilisation de la grue, équipement de confort, climatisation. Cabine mobile sur le bras télescopique offrant une visibilité optimale et verrouillable automatiquement avec le châssis porteur.
Dispositifs de sécurité	Contrôleur de charge LICCON2, fin de course crochet haut, clapets de sécurité en cas de ruptures de flexibles. Système de test pour faciliter l'entretien.
Flèche télescopique	Structure résistante au voilage et à la torsion en acier à grains fins très résistant avec profil de flèche ovale, 1 élément de base et 5 éléments télescopiques. Tous les éléments télescopiques peuvent être sortis individuellement et hydrauliquement grâce au système de télescopage rapide TELEMATIK. Longueur de la flèche: 27 ft – 118 ft.
Contrepoids	Contrepoids de base fixe de 14330 lbs.
Circuit électrique	Technologie de bus de données à la pointe de la technologie pour la commande des composants électriques et électroniques.

Equipements additionnels

Fléchette pliante / double	Longueur : 25 ft à 43 ft, peut être montée avec un angle de 0°, 20°, 40° et 60° avec la flèche télescopique.
Fléchette de montage	Longueur: 5 ft, intégrée à la fléchette pliante, peut être montée avec un angle de 0°, 20°, 40° et 60°.
Jeu de poulie / crochet pour la fléchette de montage	3 poulies de câble pour une capacité de charge de 55115 lbs max. Crochet simple pour une capacité de charge de 55115 lbs max.
Cabine conducteur / du grutier	Levage de la cabine au-dessus du bras télescopique.
Second treuil de levage	Pour le fonctionnement en mode 2 crochets ou lors du fonctionnement avec la fléchette pliante, quand le câble de levage principal doit rester moufler.
Pneumatiques	6 pneumatiques. Dimension des pneumatiques: 445/95 R 25 (16.00 R 25).
Entraînement 6 x 6	L'essieu 2 peut également être activé sur le terrain.
Frein complémentaire	Frein de Telma au niveau du 1er essieu.





D'autres équipements additionnels sont disponibles à la demande.

Description of symbols Explication des symboles

General symbols Symboles généraux

	Outriggers Calage		Driving speed Vitesse de translation
	Outriggers – free on tyres Calage – libre sur pneus		Gear Vitesse
	Axle Essieu		Hookblock / Capacity Moufle à crochet / Capacité de charge
	Radius Portée		Hoist gear Treuil de levage
	Boom length Longueur de la flèche		Crane carrier Châssis porteur
	Boom position Position de la flèche		Crane superstructure Partie tournante de la grue
	Counterweight Contrepoids		Standard Norme
	Tyres Pneumatiques		Gradability Aptitude à graver les pentes
	Slewing gear / Working area 360° Mécanisme d'orientation / Plage de travail 360°		Slewing gear / Working area ±10° over front Mécanisme d'orientation / Plage de travail ±10° en avant

Crane specific symbols Symboles spécifiques à la grue

	Telescopic boom Flèche télescopique		Road steering Direction sur route
	Swing away jib Fléchette pliante		All-wheel steering Direction toutes roues
	Integrated assembly jib Fléchette de montage intégrée		Angle Angle

Remarks referring to load charts

1. The lifting capacities do not exceed 85 % of the tipping load according to ASME B 30.5.
The crane's structural steelwork is in accordance with EN 13000 and ASME B 30.5.
2. For the calculation of the load charts at least a wind speed of 23 ft/s (7 m/s, 15.7 mph) and regarding the load a sail area of 1 m² per ton load and a wind resistance coefficient of 1.2 on the load have been taken into account. For lifting of loads with large sail areas and/or high wind resistance coefficients the maximum wind speed as stated in the load charts has to be reduced.
3. Lifting capacities are given in kips.
4. The weight of the hook blocks and hooks is part of the load and therefore it must be deducted from the lifting capacities.
5. Working radii are measured from the slewing centre.
6. The lifting capacities given for the telescopic boom apply if the folding jib is removed.
7. Subject to modification of lifting capacities.
8. The drive and crane cabin is retracted and locked!
9. The data of this brochure serves only for general information. All information is provided without warranty. Instructions for the correct commissioning of the crane please take from the operation manual and the load chart book.

Remarques relatives aux tableaux des charges

1. La capacité de charge ne doit pas dépasser 85 % de la charge de basculement conformément à ASME B 30.5.
La structure métallique de la grue est conforme à EN 13000 et ASME B 30.5.
2. Une vitesse de vent de 23 ft/s (7 m/s, 15.7 mph) minimum, une surface de prise au vent de 1 m² par tonne ainsi qu'un coefficient de résistance au vent de la charge 1,2 sont pris en compte pour le calcul des tableaux de charge. Lorsque des charges ayant une surface de prise au vent et/ou un coefficient de résistance au vent plus élevé(e)s sont levées, la vitesse de vent maximale indiquée dans les tableaux de charge doit être réduite.
3. Les charges sont indiquées en kips.
4. Le poids du crochet de levage resp. de la moufle à crochet est une partie de la charge et doit donc être déduit de la capacité de charge.
5. Les portées sont calculées à partir de l'axe de rotation.
6. Les charges indiquées pour la flèche télescopique sont valables lorsque la fléchette pliante est démontée.
7. Charges données sous réserve de modification.
8. La cabine de conduite et du grutier est rétractée et verrouillée!
9. Les données de cette brochure sont données à titre informatif. Ces renseignements sont sans garantie. Les consignes relatives à la bonne mise en service de la grue sont disponibles dans le manuel d'utilisation et le manuel de tableaux de charge.